



# ELECTRONIC ROTARY GEAR MOTOR SERIES AR2...SE...

## INSTALLATION AND OPERATING INSTRUCTIONS

1	GENERAL FEATURES	2
2	TECHNICAL DATA	3
3	INSTALLATION	3
4	ELECTRIC CONNECTIONS	4
5	CALIBRATION	5
	5.1 ENDSWITCHES	5
	5.2 AUXILIARY MICROSWITCHES	5
	5.3 SETTING WORKING RANGE	6
6	CONTROL STATION	7
7	PROPORTIONAL OPERATION	7
8	MAINTENANCE AND CHECKS	7
	8.1 MAINTENANCE	7
	8.2 CHECKS	8
9	REPLACEMENT	8
10	ELECTRONIC CONFIGURATION	8
	10.1 ELECTRONIC CONFIGURATION AR2...SE1 INPUT SIGNAL 0-10V OUTPUT SIGNAL 0-10V	9
	10.2 ELECTRONIC CONFIGURATION AR2...SE2 INPUT SIGNAL 4-20 mA OR 0-10V OUTPUT SIGNAL 0-10V	10
	10.3 ELECTRONIC CONFIGURATION AR2...SE4 INPUT SIGNAL 0-10V	11
	10.4 ELECTRONIC CONFIGURATION AR2...SE5 INPUT SIGNAL 4-20 mA	12
	10.5 ELECTRONIC CONFIGURATION AR2...SE7 INPUT SIGNAL 4-20 mA OUTPUT SIGNAL 0-10V	13
	10.6 ELECTRONIC CONFIGURATION AR2...SE8 INPUT SIGNAL 4-20mA OUTPUT SIGNAL 4-20mA	14

## **1 GENERAL FEATURES**

- 1.1** Installation must be performed by properly trained and experienced service technicians only.
- 1.2** Do not attempt to turn the AR gear motor shaft by hand or by means of a wrench, otherwise damage to the gear train may occur.
- 1.3** Before servicing make sure that power supply to the gear motor has been disconnected.
- 1.4** Check carefully all instructions before operating the AR gear motor automatically.
- 1.5** Each AR gear motor is supplied with a label fixed under the conduit plug.
- 1.6** The main servicing data and technical features of the gear motor are indicated on the label. All technical functions are specified in the relative technical data sheet.
- 1.7** Before installing or operating the AR gear motor make sure that its employment complies with the range of performances reported on the label.
- 1.8** When positioning the gear motor consider that it must be easily accessible in order to be able to perform wiring and adjustment of endswitches.
- 1.9** The AR gear motor can be installed in any location included in the range of electrical protection IP54, except where acid fumes or other deteriorating vapour might attack its metal parts or where gas leaks or explosive vapours are present in the atmosphere. In environments with high salt percentage, the fastening screws should be zinc or cadmium plated, not made of brass or stainless steel.

## 2 TECHNICAL DATA

Body and cover	: die-cast aluminium
Output torque	: 4 ÷ 20 Nm
Maintaining torque	: 4 ÷ 20 Nm
Stroking time	: 7,5 ÷ 60 seconds for 90° at 50 Hz
Output shaft	: Ø 12 mm with □ 9,5 mm
Installation	: in any position
Ambient temperature	: -10 ÷ 60 °C
Weight	: ~ 2,5 kg
Main supply	: 24 Vac / 50-60 Hz on request with transformer 230Vac or 115Vac / 24 Vac 50 – 60 Hz
Adsorbed power	: 7 VA
Input signal	: according to model [refer to § 10]
Input signal impedance	: according to model [refer to § 10]
Local control station	: Auto/Manual and Open/Close/Stop
Rating of el. contacts limit and auxiliary switches	: 0,5 A / 48 Vdc and Vac
Enclosure Rating	: IP 54 according to IEC 529
Duty cycle	: continuous 100%
Conduit knockouts	: 2 x Pg 13,5

## 3 INSTALLATION

- 3.1** The AR gear motor must be positioned so that the square shaft [**POWER END**] is turned towards the device to be put in motion.
- 3.2** If no other adjustment of the rotation angle is expressly requested, the AR2...E gear motor is always supplied from the factory with standard adjustment of endswitches for a 90° rotation.
- 3.3** The square shaft on the POWER END side is positioned in the factory as shown in picture 1.

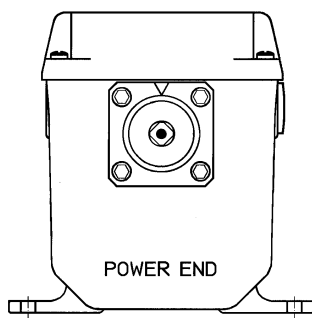

Picture n. 1

## 4 ELECTRIC CONNECTIONS

- 4.1** After having installed the AR gear motor and before fastening it mechanically to the device to be controlled, proceed with wiring and earthing.
- 4.2** The wiring diagrams are reported both in the attached technical bulletin and on the plate inside the cover.
- 4.3** Warning: before servicing make sure that power supply is disconnected by means of the two-pole-switch [phase and neutral]. In case of non-observance, damages to people and to the equipment may occur.
- 4.4** External supply voltage transformer with load > 15VA protected against overloading.
- 4.5** To accede to the internal wiring terminal board remove the cover by loosening the 4 fastening screws.
- 4.6** On the frame of the AR gear motor are located 2 threaded holes for the fitting of the conduit plug PG 13.5 and 2 extra ¼" holes [on request] if pressurizing of the motor is requested.
- 4.7** All wires must comply with local prescriptions and, in any case, their section must be ranging between 1 and 1.5 mm<sup>2</sup>.
- 4.8** Connection piping recommended HO7V-U...G 1.5 mm<sup>2</sup>.
- 4.9** The wiring diagrams show the AR2...E gear motor at end position closed [0°].

**WARNING** An immediate accident may occur onto circuit board due to wrong wiring. Check it **carefully** before servicing.

- 4.10** The auxiliary microswitches are single-pole double through and are voltage-free.
- 4.11** The auxiliary microswitches rating is 0,5 A / 48 Vdc e Vac.
- 4.12** Make sure that power supply and system frequency match to the values indicated on the AR gear motor's plate.

**WARNING** Transformer power supply must be separated from that of the gear motor.

- 4.13** The low-tension signalling cables [tension lower than 48V] must be laid separately from the higher-tension-conduits [tension higher than 48V]. In case they are laid in a single channel, screened cables must be used.

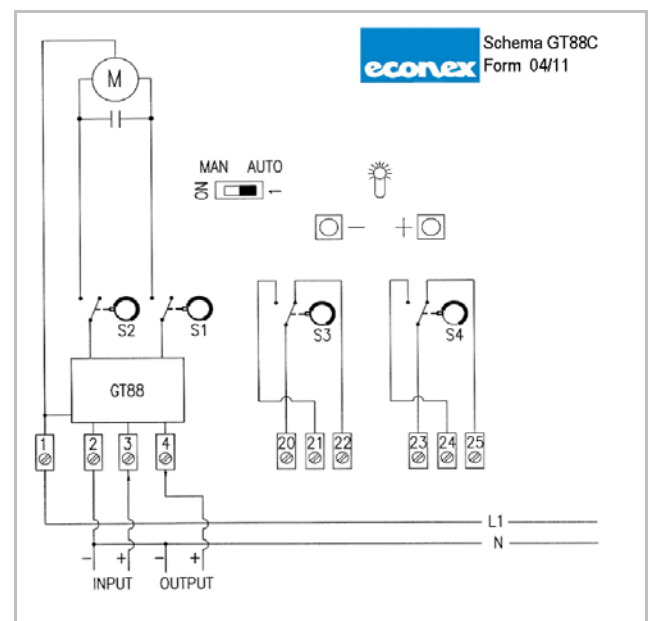
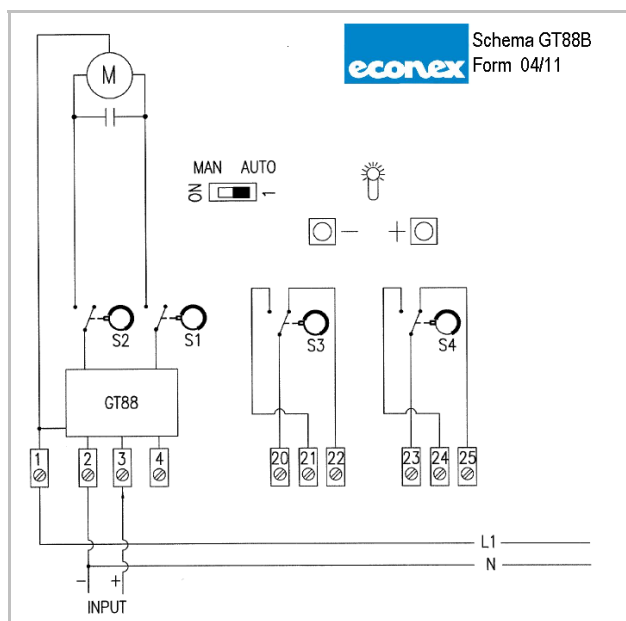

**Valid only for AR2...SE1, SE2, SE7 e SE8**

## 5 CALIBRATION

### 5.1 ENDSWITCHES

As already reported in chapter 3 paragraph 3.2, the AR electronic gear motor is supplied by the factory with adjustment foreseen for a maximum 90° rotation angle. On request is also available a circuit board with SPAN features, i.e. Starting Point and WORKING RANGE regulation.

### 5.2 AUXILIARY MICROSWITCHES

- 5.2.1 The AR gear motor is supplied with 2 auxiliary microswitches that can be adjusted in any position of the rotation angle.
- 5.2.2 For cam adjustment, use the proper key supplied with the AR gear motor equipment and installed inside.
- 5.2.3 Use the key by the right side, introducing the pin into one of the holes on the sides of the blue cam "S3" or "S4" according to the need and lift it to required angle position [Picture 2].
- 5.2.4 By the blue cam in the rearmost position, at first use the lever on its curved side to move the blue cam to a more suitable position to perform adjustment.
- 5.2.5 Cam adjustment is possible in both directions and along the whole rotation angle of the camshaft.



Picture n. 2

- 5.2.6 Remove the key before servicing.
- 5.2.7 Run the AR gear motor for a few cycles making sure that the right cam adjustment has been achieved.
- 5.2.8 Once all adjustments have been carried out, return the key inside the AR gear motor and reinstall the cover by fastening the 4 screws.
- 5.2.9 Reinstall the control lever system of the AR gear motor and test the whole system works properly.

### 5.3 SETTING WORKING RANGE

One of the features of actuators series AR2...-SE, is the possibility to reduce the working range of the actuator, i.e. contract the working range from 90° to 45° by utilizing the whole input signal 4-20 mA or 0-10 V.

In order to limit the working range follow these steps:

1. Turn the trimmer screw (shown in the picture) counter-clockwise for about 20 turns, the screw in endless.

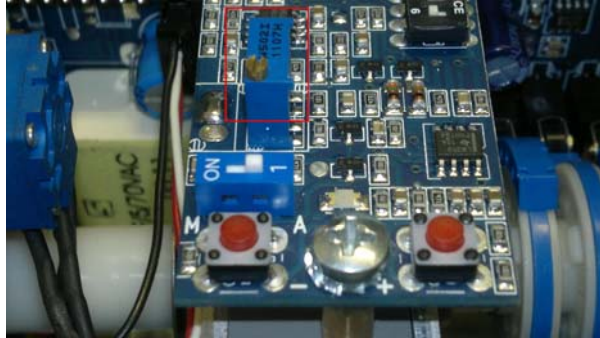

2. Supply power and set the input signal to the maximum value (i.e. 20 mA or 10V) and the actuator will turn :
  - ◆ with rotation clockwise (dip-switch no. 1 on the right handside) up to 45°. Then the actuator will rotate by 45° between 45° and 0° with the entire signal 4-20 mA or 0-10V.
  - ◆ with rotation counter-clockwise (dip-switch no. 1 on the left handside) up to 90°. Then the actuator will rotate by 45° between 90° up to 45° with the entire signal 4-20 mA or 0-10V.
3. In order to widen the working range it is possible to set any degree of angle between 45° and 90° with a fine regulation.  
Supply power and set the input signal to the maximum value (i.e. 20 mA or 10V) and turn the trimmer screw (as shown in the picture) clockwise, the actuator will extend his working range by approx one degree for each turn of the screw. Once you set the desired working range, the actuator will rotate within this angle (i.e. 60°) with the entire input signal 4-20 mA or 0-10V.

## 6 CONTROL STATION

AR2 gear motors are equipped with control station, which works as follows:

- 6.1 Connect phase L1 to terminal # 1 and neutral N to terminal # 2.
- 6.2 Set the AUTO/MAN dip-switch on manual position [ON] at the left.
- 6.3 A red LED will light up to show the manual working way.
- 6.4 Push red knobs - / + to rotating the shaft clockwise or counterclockwise.
- 6.5 Re-set the dip-switch onto automatic way [pos. 1 on the right] when manual calibration is finished. the red LED will light off.



Picture n. 3

## 7 PROPORTIONAL OPERATION

- 7.1 All adjustments are already set at factory. Hence, it is recommended to **avoid** any intervention on cams and potentiometer.
- 7.2 Warning: potentiometer is installed for card balancing purposes **ONLY**. Consequently, it is not to be used.

## 8 MAINTENANCE AND CHECKS

### 8.1 MAINTENANCE

- 8.1.1 AR2 gear motor does not require any particular current maintenance.
- 8.1.2 AR2 gear motor does not require any lubrication since the gear box is lubricated at factory.
- 8.1.3 Avoid any on field reparation.
- 8.1.4 Do not disassemble any internal part of the AR2...E gear motor. In case of non-functioning, after having performed all possible checks on field, the gear motor must be returned to the factory for any possible repair. Any replacement must be carried out by qualified technicians only.

## 8.2 CHECKS

After installation and adjustment of the control lever system check that switch and wiring of the circuit are correct.

Check that the AR2...E rotary gear motor duly controls the device it is meant for.

Check that the AR2...E gear motor runs in accordance with the given manual input.

Check that the AR2...E gear motor, the lever system and the controlled device are mechanically connected in a correct and safe way.

Check that the levers' movements occur smoothly without jamming or blocking due to other objects.

## 9 REPLACEMENT

In case replacement of the AR2...E gear motor is necessary, proceed as follows:

- disconnect power supply from the AR2...E motor
- remove the gear motor's cover
- disconnect electric wiring
- remove the levers between the AR2...E gear motor and the controlled device
- install the new gear motor proceeding as per instructions given in the foregoing chapters

## 10 ELECTRONIC CONFIGURATION

The digital electronic board mounted on AR2 gear actuator enable to set various features / options, like rotation direction, resolution, type of input control signal and impedance.

**WARNING** For each model there is a specific electronic board, with its own specification in hardware and software.

The desired configuration can be obtained by setting dip-switch of the electronic board on the right or left hand side, according to the below indicated schemes.

Dip-switches are located under the paperboard panel over the horizontal board. Lift the rectangular paperboard to access the dip-switches



**10.1 ELECTRONIC CONFIGURATION AR2...SE1 INPUT SIGNAL 0-10V OUTPUT SIGNAL 0-10V**

<b>DIP SWITCH POSITION</b>		
<b>DIP SWITCH</b>	<b>DIP SWITCH ON LEFT OFF</b>	<b>DIP SWITCH ON RIGHT ON</b>
<b>1</b>	Clockwise Rotation (from Power End side)	Counter-Clockwise Rotation (from Power End side)
<b>2</b>	Low Resolution 125 steps	High Resolution 200 steps
<b>3</b>	Standard setting (**) INPUT and OUTPUT always aligned	
<b>4</b>	Standard setting (**) INPUT and OUTPUT always aligned	
<b>5</b>	Input Signal 0-10 V d.c.	N.A.
<b>6</b>	Impedance at 4400 Ohm (only for Input Signal 0-10V).	Impedance at 250 Ohm (only for Input Signal 0-10V).

\*\* For other setting please look here below:

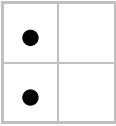
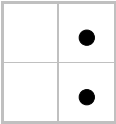
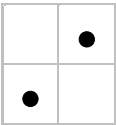
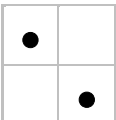
3 4	OFF		ON	STANDARD setting, Input and Output signal always aligned. For example 2V input e 2V output.
3 4	OFF		ON	REVERSE OUTPUT (only for counter-clockwise rotation). For example 2V Input signal and 8V Output Signal.
3 4	OFF		ON	DS-3 turned ON and DS-4 turned OFF. Actuator rotates for 90° with Mid-Low Input Signal. For example 0-5V with rotation of 90°.
3 4	OFF		ON	DS-3 turned OFF and DS-4 turned ON. Actuator rotates for 90° with Mid-High Input Signal. For example 5-10V with rotation of 90°.

**10.2 ELECTRONIC CONFIGURATION AR2...SE2 INPUT SIGNAL 4-20 mA OR 0-10V OUTPUT SIGNAL 0-10V**

<b>DIP SWITCH POSITION</b>		
<b>DIP SWITCH</b>	<b>DIP SWITCH ON LEFT OFF</b>	<b>DIP SWITCH ON RIGHT ON</b>
<b>1</b>	Clockwise Rotation (from Power End side)	Counter-Clockwise Rotation (from Power End side)
<b>2</b>	Low Resolution 125 steps	High Resolution 200 steps
<b>3</b>	Standard setting (**) INPUT and OUTPUT always aligned	
<b>4</b>	Standard setting (**) INPUT and OUTPUT always aligned	
<b>5</b>	Input Signal 0-10 V d.c.	Input Signal 4 – 20 mA DS-6 MUST be turned ON
<b>6</b>	Impedance at 4400 Ohm (only for Input Signal 0-10V). Always turned ON with Input Signal 4-20 mA	Impedance at 250 Ohm (only for Input Signal 0-10V).

\*\* For other setting please look here below:

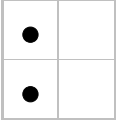
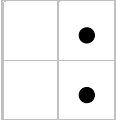
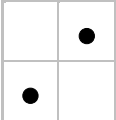
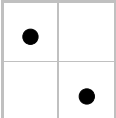
<p><b>3</b> <b>4</b></p>	<p><b>OFF</b></p>  <p><b>ON</b></p>	<p>STANDARD setting, Input and Output signal always aligned. For example 2V input e 2V output.</p>
<p><b>3</b> <b>4</b></p>	<p><b>OFF</b></p>  <p><b>ON</b></p>	<p>REVERSE OUTPUT (only for counter-clockwise rotation). For example 2V Input signal and 8V Output Signal.</p>
<p><b>3</b> <b>4</b></p>	<p><b>OFF</b></p>  <p><b>ON</b></p>	<p>DS-3 turned ON and DS-4 turned OFF. Actuator rotates for 90° with Mid-Low Input Signal. For example 0-5V with rotation of 90°.</p>
<p><b>3</b> <b>4</b></p>	<p><b>OFF</b></p>  <p><b>ON</b></p>	<p>DS-3 turned OFF and DS-4 turned ON. Actuator rotates for 90° with Mid-High Input Signal. For example 5-10V with rotation of 90°.</p>

### 10.3 ELECTRONIC CONFIGURATION AR2...SE4 INPUT SIGNAL 0-10V

DIP SWITCH POSITION		
DIP SWITCH	DIP SWITCH ON LEFT OFF	DIP SWITCH ON RIGHT ON
1	Clockwise Rotation (from Power End side)	Counter-Clockwise Rotation (from Power End side)
2	Low Resolution 125 steps	High Resolution 200 steps
3	Please refer to the below reported scheme**	
4		
5	Input Signal 0-10 V	N.A.
6	Impedance at 4400 Ohm (only for Input Signal 0-10V).	Impedance at 250 Ohm (only for Input Signal 0-10V).

\*\* For special setting please look here below:

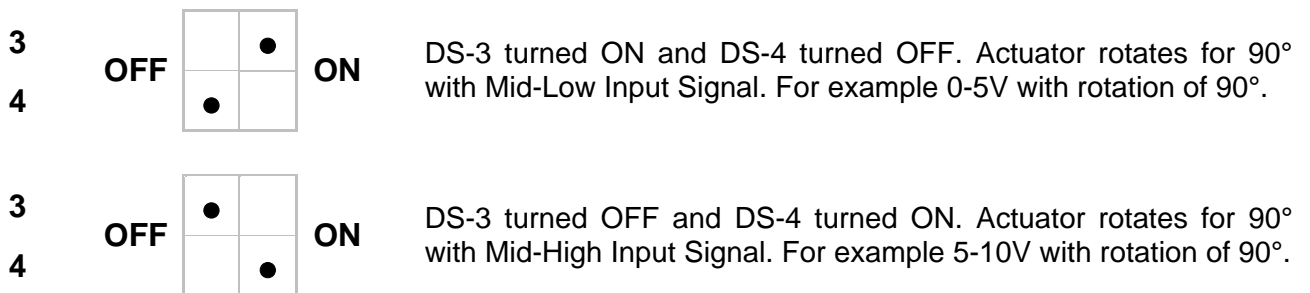

## 10.4 ELECTRONIC CONFIGURATION AR2...SE5 INPUT SIGNAL 4-20 mA

DIP SWITCH POSITION		
DIP SWITCH	DIP SWITCH ON LEFT OFF	DIP SWITCH ON RIGHT ON
1	Clockwise Rotation (from Power End side)	Counter-Clockwise Rotation (from Power End side)
2	Low Resolution 125 steps	High Resolution 200 steps
3	Please refer to the below reported scheme	
4		
5	N.A.	Input Signal 4 – 20 mA
6	N.A.	DS-6 MUST be turned ON

\*\* For special setting please look here below:

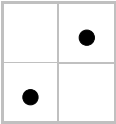
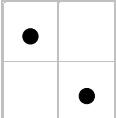
3	OFF		ON	DS-3 turned ON and DS-4 turned OFF. Actuator rotates for 90° with Mid-Low Input Signal. For example 4-12 mA with rotation of 90°.
4				
3	OFF		ON	DS-3 turned OFF and DS-4 turned ON. Actuator rotates for 90° with Mid-High Input Signal. For example 12-20 mA with rotation of 90°.
4				

DIP SWITCH POSITION		
DIP SWITCH	DIP SWITCH ON LEFT OFF	DIP SWITCH ON RIGHT ON
1	Clockwise Rotation (from Power End side)	Counter-Clockwise Rotation (from Power End side)
2	Low Resolution 125 steps	High Resolution 200 steps
3	Standard setting (**) INPUT and OUTPUT always aligned	
4	Standard setting (**) INPUT and OUTPUT always aligned	
5	N.A.	Input Signal 4 – 20 mA
6	N.A.	DS-6 MUST be turned ON

\*\* For other setting please look here below:

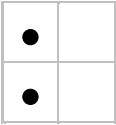
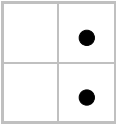
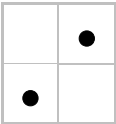
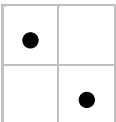
3 4	OFF		ON	STANDARD setting, Input and Output signal always aligned. For example 2V input e 2V output.
3 4	OFF		ON	REVERSE OUTPUT (only for counter-clockwise rotation). For example 2V Input signal and 8V Output Signal.
3 4	OFF		ON	DS-3 turned ON and DS-4 turned OFF. Actuator rotates for 90° with Mid-Low Input Signal. For example 0-5V with rotation of 90°.
3 4	OFF		ON	DS-3 turned OFF and DS-4 turned ON. Actuator rotates for 90° with Mid-High Input Signal. For example 5-10V with rotation of 90°.

DIP SWITCH POSITION		
DIP SWITCH	DIP SWITCH ON LEFT OFF	DIP SWITCH ON RIGHT ON
1	Clockwise Rotation (from Power End side)	Counter-Clockwise Rotation (from Power End side)
2	Low Resolution 125 steps	High Resolution 200 steps
3	Standard setting (**) INPUT and OUTPUT always aligned	
4	Standard setting (**) INPUT and OUTPUT always aligned	
5	N.A.	Input Signal 4 – 20 mA
6	N.A.	DS-6 MUST be turned ON

\*\* For other setting please look here below:

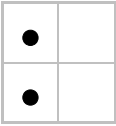
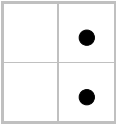
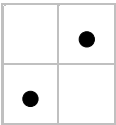
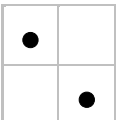
3 4	OFF		ON	STANDARD setting, Input and Output signal always aligned. For example 2V input e 2V output.
3 4	OFF		ON	REVERSE OUTPUT (only for counter-clockwise rotation). For example 2V Input signal and 8V Output Signal.
3 4	OFF		ON	DS-3 turned ON and DS-4 turned OFF. Actuator rotates for 90° with Mid-Low Input Signal. For example 0-5V with rotation of 90°.
3 4	OFF		ON	DS-3 turned OFF and DS-4 turned ON. Actuator rotates for 90° with Mid-High Input Signal. For example 5-10V with rotation of 90°.

This manual can be amended without any obligation of notice